

FXR-Y08

Rearset

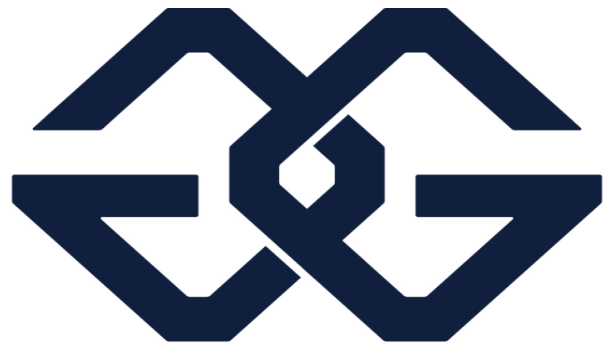

GILLES

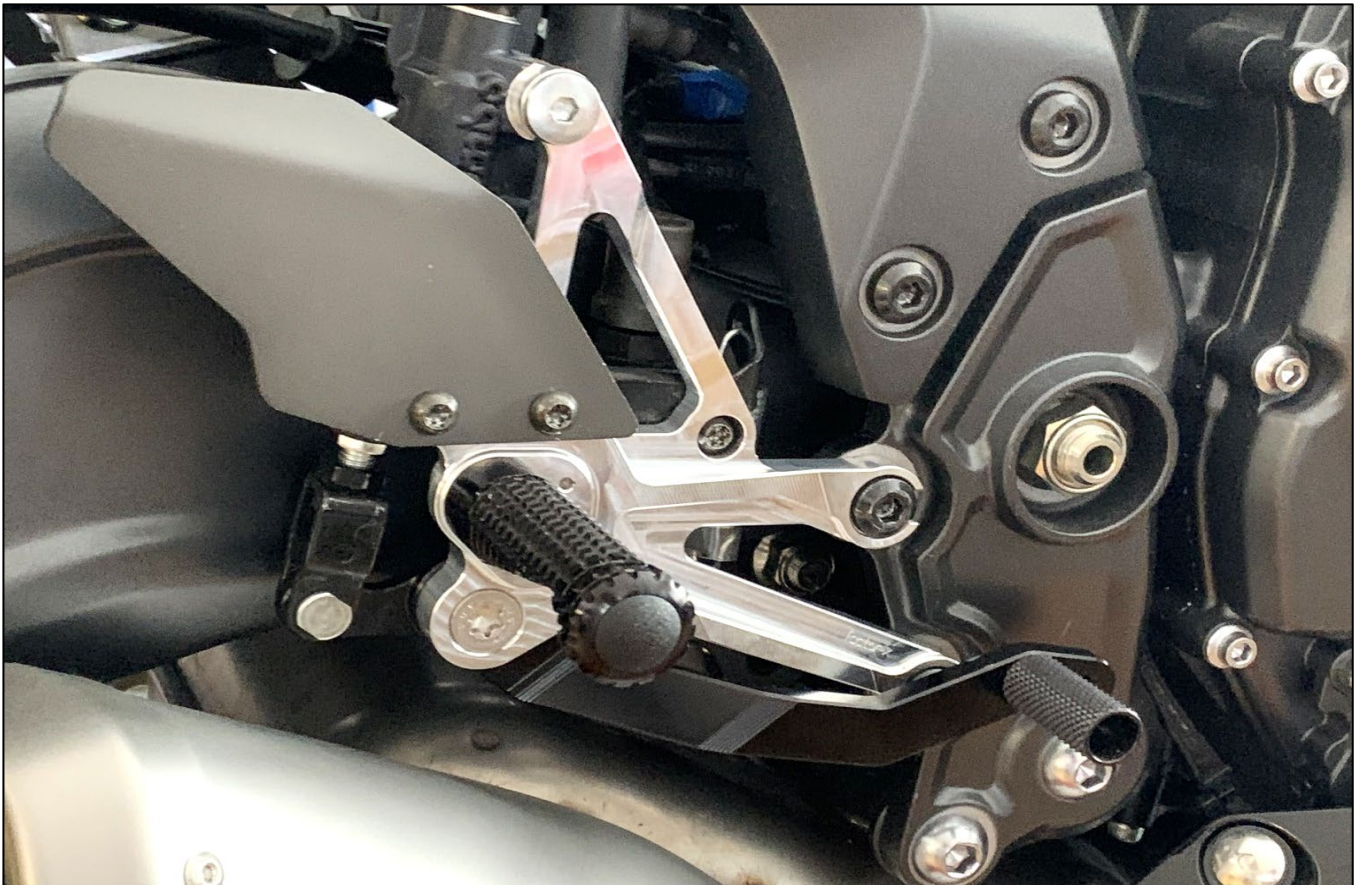

DE

Warnhinweise

⚠ GEFAHR

Weist auf eine Gefährdung mit hohem Risikograd hin, die bei Nichtbeachtung zum Tod oder einer schweren Verletzung führt.

📄 ACHTUNG

Besondere Hinweise und Vorsichtsmaßnahmen. Die Nichtbeachtung kann zu einer Beschädigung am Fahrzeug oder Bauteilen führen.

📄 HINWEIS

Besondere Hinweise zur vereinfachten Handhabung und Montage.

Allgemeine Hinweise

- Es wird empfohlen den Artikel von einer Fachwerkstatt installieren zu lassen!
- Diese Anbauanleitung ist sorgfältig vor Beginn der Montagearbeiten durchzulesen und der Lieferumfang ist auf Vollständigkeit zu überprüfen.
- Nichtbeachtung der Anweisung kann zu Beschädigungen des Fahrzeuges, des Produktes bzw. zur Gefährdung des Fahrers führen.
- Für Schäden, die aufgrund von Nichtbeachtung unserer Anweisungen entstanden sind, können wir keine Haftung oder Gewährleistung übernehmen.
- Ein unsicher aufgestelltes Motorrad kann bei den folgenden Arbeiten umfallen! Achten Sie darauf, dass das Fahrzeug sicher steht.
- Verbrennungsgefahr bei heissem Motor und Auspuff! Heiße Fahrzeugteile abkühlen lassen.
- Die Montage und Funktion bezieht sich ausschließlich auf Serienmotorräder.
- Bewahren Sie die Anbauanleitung sorgfältig auf und geben Sie dieses Produkt nur mit Anbauanleitung weiter.

Montagehinweise

- Alle nicht benannten Drehmomente gemäß Herstellerangaben oder falls nicht vorhanden nach DIN/ISO festziehen.
- Arbeiten und Entlüftung am Bremssystem sind von einer Fachwerkstatt durchführen zu lassen.
- Achten Sie auf Freigängigkeit bei Zügen, Kabeln und Leitungen, um Spannungen und Quetschen zu vermeiden.
- In regelmäßigen Abständen sind alle Schraubverbindungen auf ihren festen Sitz zu überprüfen.

Betriebserlaubnis

- Diese Fußrastenanlage benötigt für die erforderliche TÜV-Konformität, um eine legale Nutzung im öffentlichen Straßenverkehr zu ermöglichen, klappbare Rasten. Nur mit diesen klappbaren Rasten erfüllt die Fußrastenanlage die Anforderung des TÜV Zertifikat 144XT0020. Ein Eintrag in die Fahrzeugpapiere ist erforderlich!

GB

Warning instructions

⚠ DANGER

Relates to a hazard with high degree of risk. If not complied with, may lead to death or serious injury.

📄 ATTENTION

Special instructions and precautions. Non-compliance may result in damage to the vehicle or components.

📄 NOTE

Special instructions for simplified handling and assembly.

General notes

- It is recommended that the article is installed by a specialist workshop.
- Read through these instructions carefully before starting assembly and check that the delivery is complete.
- Non-compliance with the instructions may result in damage to the vehicle or to the product and/or endanger the driver.
- We cannot accept liability or offer any guarantee for damage arising from non-compliance with our instructions.
- An insecurely positioned motorcycle may tip over during the following work! Make that the vehicle is safely supported when standing.
- Danger of burns in the case of hot engine and exhaust! Allow hot vehicle parts to cool.
- Assembly and function relate exclusively to standard production motorcycles.
- Keep these instructions safe and ensure that they are included with any transfer of the vehicle.

Assembly instructions

- All unspecified torques should be tightened according to manufacturer's instructions or, if not present, in accordance with DIN/ISO.
- Work on and venting of the brake system must be carried out by a specialist workshop.
- Ensure the freedom of movement of Bowden cables, cables and wires in order to avoid tension and crimping.
- All bolted connections should be checked for secure seating at regular intervals.

Operating licence

- To comply with TÜV (Technical Inspection Organization), which is necessary to permit legal use on public highways, this rearset requires hinged pegs. Only with these hinged pegs does the rearset fulfil the requirements of the TÜV certification 144XT0020. A entry in the vehicle's registration paper's is required.

F**Avvertissements****⚠ DANGER**

Indique un danger à haut degré de risque qui, s'il n'est pas pris en compte, est susceptible d'entraîner des blessures graves, voire la mort.

📄 ATTENTION

Indications spécifiques et mesures de précaution. Leur non-respect est susceptible d'occasionner des dommages au véhicule ou à ses composants.

📄 NOTE

Indications spécifiques visant à simplifier le maniement et le montage.

Indications d'ordre général

- Il est recommandé de faire installer l'article par un atelier spécialisé.
- Ces instructions de montage doivent être lues attentivement avant de commencer les travaux de montage et le contenu de la livraison doit être vérifié pour s'assurer qu'il est bien complet.
- Le non-respect de ces instructions est susceptible d'occasionner des dommages au véhicule ou au produit, ou bien de mettre en danger le conducteur.
- Nous déclinons toute responsabilité et ne prenons en charge aucune garantie pour tous les dommages, qui seraient causés par le non-respect de nos instructions.
- Une moto mal mise en place est susceptible de tomber lors des travaux effectués dessus par la suite ! S'assurer que le véhicule est bien stable.
- Risque de brûlures lorsque le moteur et le tuyau d'échappement sont chauds ! Laisser refroidir les pièces chaudes du véhicule.
- Le montage et le fonctionnement ne concernent que les motos de série.
- Conserver soigneusement les instructions de montage et ne remettre ce produit qu'avec ses instructions de montage.

Indications relatives au montage

- Lorsqu'un couple de serrage n'est pas précisé, effectuer le serrage suivant les indications fournies par le fabricant, ou bien, s'il n'y en a pas, suivant les spécifications de la norme DIN/ISO.
- La purge du système de freinage et tous les autres travaux à réaliser sur celui-ci doivent être effectués par un atelier spécialisé.
- S'assurer que les câbles Bowden, les câbles et les conduites sont bien libres de bouger afin d'éviter tout écrasement ou tension.
- Tous les raccords à vis doivent être vérifiés à intervalles réguliers pour s'assurer qu'ils sont bien serrés.

Autorisation d'exploitation

- Pour obtenir la conformité requise par le TÜV lui permettant d'être utilisé légalement sur la voie publique, ce système de repose-pieds nécessite de posséder des éléments rabattables. Seule la présence d'éléments rabattables permet à ce système de repose-pieds de satisfaire aux exigences de l'TÜV certificat 144TX0020. Une inscription dans les papiers du véhicule est obligatoire!

I**Avvertenze****⚠ PERICOLO**

Segnala una condizione di pericolo con un elevato grado di rischio che, in caso di inosservanza, può portare al decesso oppure a una lesione grave.

📄 ATTENZIONE

Indicazioni speciali e precauzioni. L'inosservanza può comportare un danneggiamento al veicolo oppure ai componenti.

📄 NOTA

Indicazioni speciali per semplificare la movimentazione e il montaggio.

Indicazioni generali

- Si consiglia di far installare l'articolo da un'officina specializzata.
- Queste istruzioni di montaggio devono essere lette attentamente prima di dare inizio ai lavori di montaggio e l'ambito di fornitura deve essere verificato in termini di completezza.
- L'inosservanza delle istruzioni può comportare un danneggiamento al veicolo, al prodotto oppure la messa in pericolo del conducente.
- Noi non possiamo assumerci alcuna responsabilità né possiamo fornire alcuna garanzia per i danni insorti in seguito all'inosservanza delle nostre istruzioni.
- Una motocicletta, tenuta eretta in modo precario, può cadere a terra durante lo svolgimento dei seguenti lavori! Prestare attenzione affinché il veicolo poggi stabilmente.
- Pericolo di ustione in presenza di motore e scarichi bollenti! Far raffreddare le parti calde dei veicoli.
- Il montaggio e il funzionamento si riferisce esclusivamente alle motociclette di serie.
- Conservare le istruzioni di montaggio accuratamente e, in caso di cessione, questo prodotto deve essere sempre accompagnato dalle istruzioni di montaggio.

Indicazioni di montaggio

- Stringere tutti i momenti torcenti, non citati, secondo le indicazioni del produttore oppure, se assenti, secondo DIN/ISO.
- Far eseguire i lavori e la disaerazione sul sistema di frenatura da un'officina specializzata.
- Prestare attenzione alla libertà di movimento in presenza di tiranti Bowden, cavi e linee per evitare tensionamenti e schiacciamenti.
- Ad intervalli regolari assicurarsi che tutti i collegamenti a vite siano saldamente fissati nella loro sede.

Licenza di esercizio

- Questo poggiatesta ha bisogno di supporti ribaltabili per la conformità TÜV necessaria per consentire un utilizzo legale nel trasporto stradale pubblico. Il poggiatesta soddisfa il requisito della norma TÜV certificato 144XT0020 solo con questi supporti ribaltabili. Una registrazione nei documenti del veicolo è necessario!

ES

Indicaciones de advertencia

⚠ PELIGRO

Hace referencia a un peligro con un elevado riesgo que, en caso de inobservancia, puede provocar la muerte o lesiones graves.

👉 ATENCION

Indicaciones especiales y medidas de prevención. Su inobservancia puede provocar daños en el vehículo o en componentes.

📄 NOTA

Indicaciones especiales para una manejo y un montaje sencillos.

Indicaciones generales

- Se recomienda encargar la instalación del artículo a un taller especializado.
- Antes de iniciar los trabajos de montaje es necesario leer atentamente estas instrucciones de montaje y verificar que el volumen de suministro está completo.
- Si no se observan las instrucciones se pueden provocar daños en el vehículo, el producto, o se puede poner en riesgo al conductor.
- Por los daños provocados por inobservancia de nuestras instrucciones no asumimos ninguna responsabilidad ni garantía.
- ¡Una motocicleta estacionada de forma insegura puede caerse al realizar los siguientes trabajos! Preste atención a que el vehículo se mantenga de pie con seguridad.
- ¡Peligro de quemaduras con el motor y el sistema de escape calientes! Dejar que se enfríen las piezas del vehículo que estén calientes.
- El montaje y el funcionamiento hacen referencia solamente a motocicletas de serie.
- Conserve las instrucciones de montaje en un lugar seguro y entregue este producto a terceros solamente con dichas instrucciones.

Indicaciones para el montaje

- Todos los pares no mencionados se deben apretar según las indicaciones del fabricante o, en su defecto, según las normas DIN/ISO.
- Los trabajos en el sistema de frenado y el purgado de aire deben ser realizados por un taller especializado.
- Preste atención a que los cables Bowden, cables y conductos se muevan con libertad para evitar tensiones y aplastamientos.
- Se debe comprobar con regularidad que las uniones atornilladas están firmes.

Permiso de funcionamiento

- Para un uso legal en las vías públicas, este sistema de estriberas necesita estriberas plegables para la conformidad TÜV necesaria. El sistema de estriberas solamente cumple los requisitos de TÜV certificado 14XT0020 con estas. Se requiere una entrada en los oclumentos del vehículo.

POS.	ARTIKELNUMMER ARTICLE NO.	BESCHREIBUNG DESCRIPTION	VARIANTE VARIANT <i>BLACK</i>	MENGE [qty]
1	FXR-GL-Y08	Base Plate Left	Anodized Black	1
2	UF-18	Footrest	Anodized Black	1
3	US-75	Gear Lever	Anodized Black	1
4	UTR-03-IT	Gear Lever Toe Piece	Anodized Black	1
5	UTR-24	Rubber Toe Piece	-	1
6	CAR-16-L	Heel Protector Left	Anodized Black	1
7	USW08	Gear Shaft	Anodized Black	1
8	DS-24-10,2-8	Spacer	Anodized Black	1
9	SPS-22	Adapter	TENIFER QPQ	1
10	SFL16x0.8-2	Plug	-	1
11	SR22x1-472-VA	Circlip	-	1
12	D3x8-2338-VA	Cylinder Pin	-	1
13	GAKFL6	Ball And Socket Bearing	-	1
14	42750PE	Plug	-	1
15	M6-L-4032-VA	Hexagon Nut LH	-	1
16	M8x25-7380-VA	Half Round Head Screw	-	1
17	M8x20-4762-VA	Cylinder Head Screw	-	1
18	M6x30-4026-VA	Setscrew	-	1
19	M6x16-7380-VA-PRE10-1	Half Round Head Screw	-	1
20	M6x10-7380-8.8-TX-VZS	Half Round Head Screw	Galvanized Black	2

UF-27-Kit

not included but necessary
for legal street use to comply the
certification TGA: 144XT0020

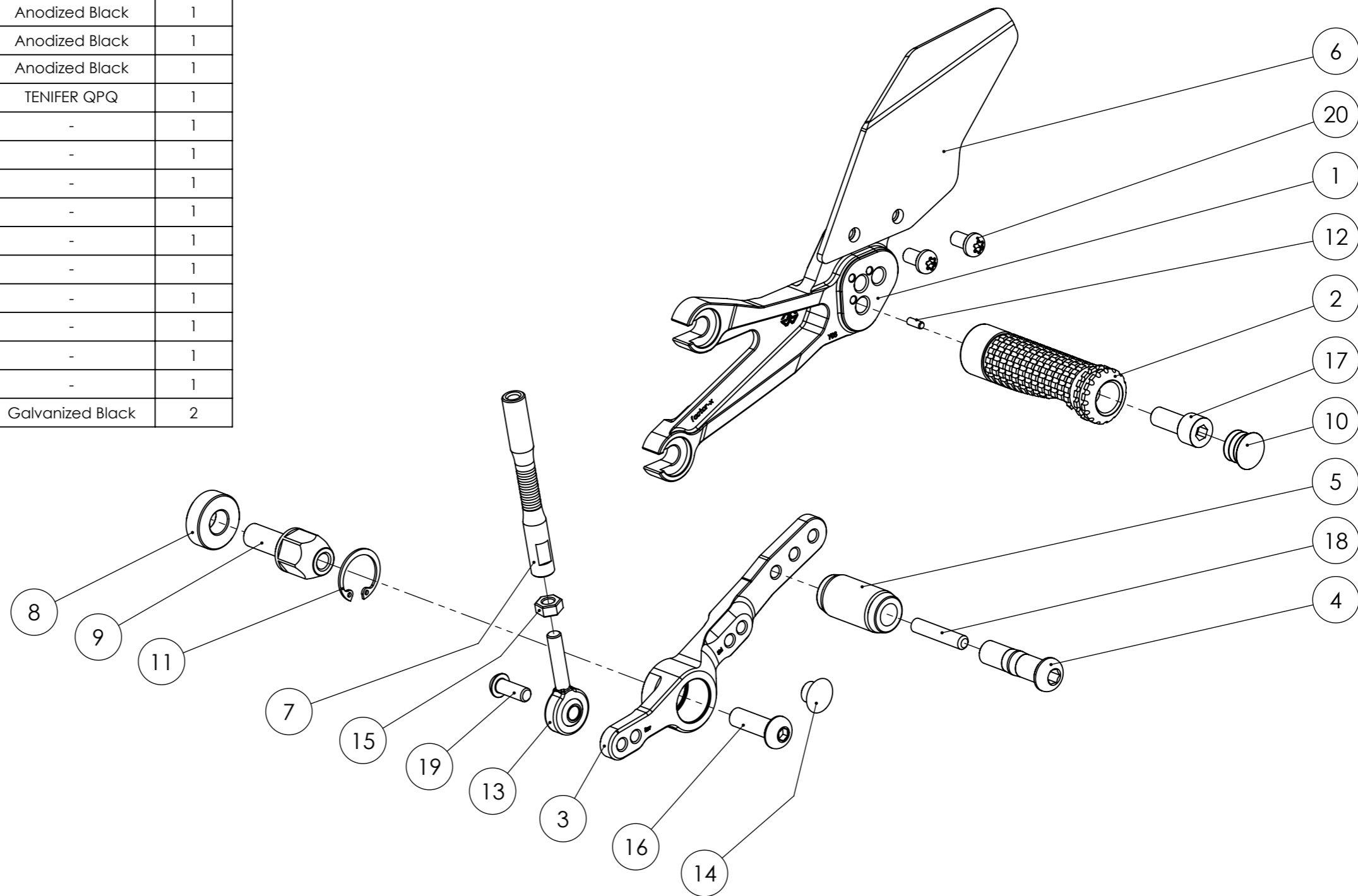
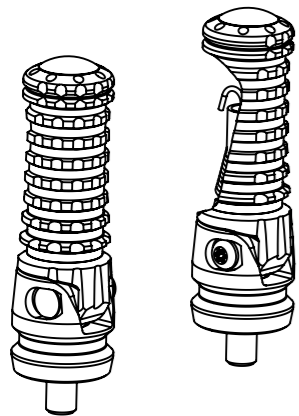

POS.	ARTIKELNUMMER ARTICLE NO.	BESCHREIBUNG DESCRIPTION	VARIANTE VARIANT <i>BLACK</i>	MENGE <i>[qty]</i>
1	FXR-GR-Y08	Base Plate Right	Anodized Black	1
2	UF-18	Footrest	Anodized Black	1
3	UB-60	Foot Brake Lever	Anodized Black	1
4	UTR-09	Brake Lever Toe Piece	Anodized Black	1
5	CAR-16-R	Heel Protector Right	Anodized Black	1
6	SPN-8-10.2	Special Nut	-	1
7	SFL16x0.8-2	Plug	-	1
8	SPL-1,6-VA	Splint Pin	-	1
9	D3x8-2338-VA	Cylinder Pin	-	1
10	M8x35-14581-VA	Countersunk Head Screw	-	1
11	M8x20-4762-VA	Cylinder Head Screw	-	1
12	M6x20-14579-VA	Cylinder Head Screw	-	1
13	M6x10-7380-8.8-TX-VZS	Half Round Head Screw	Galvanized Black	4

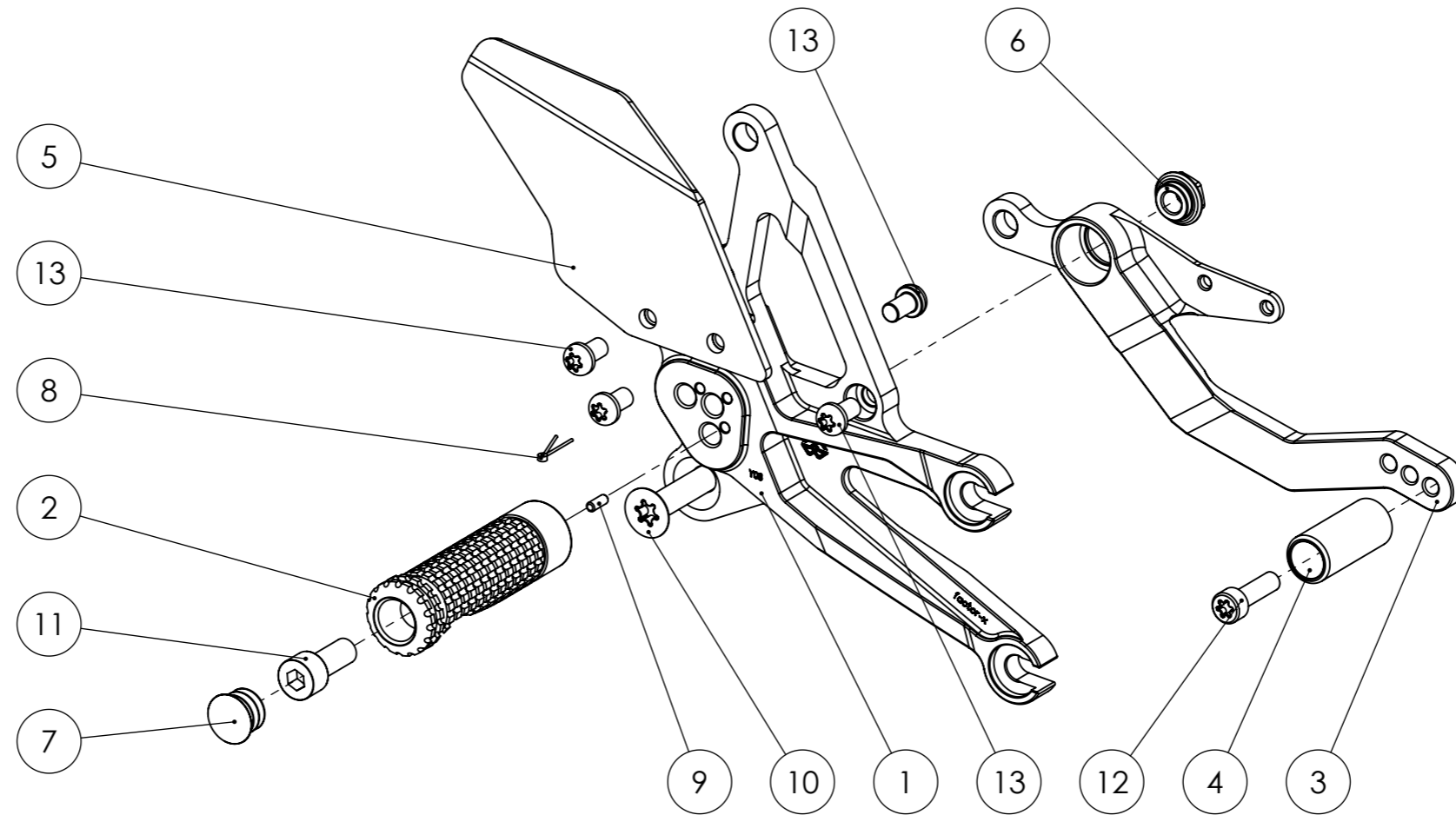

FXR-Y08

Rearset

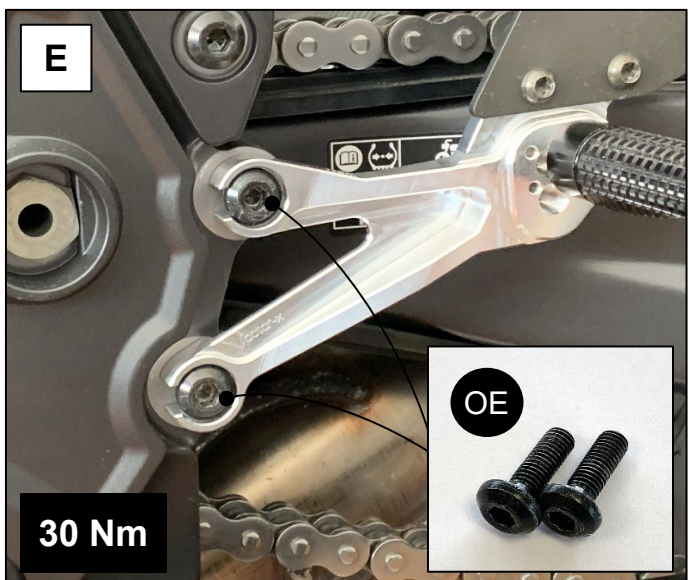
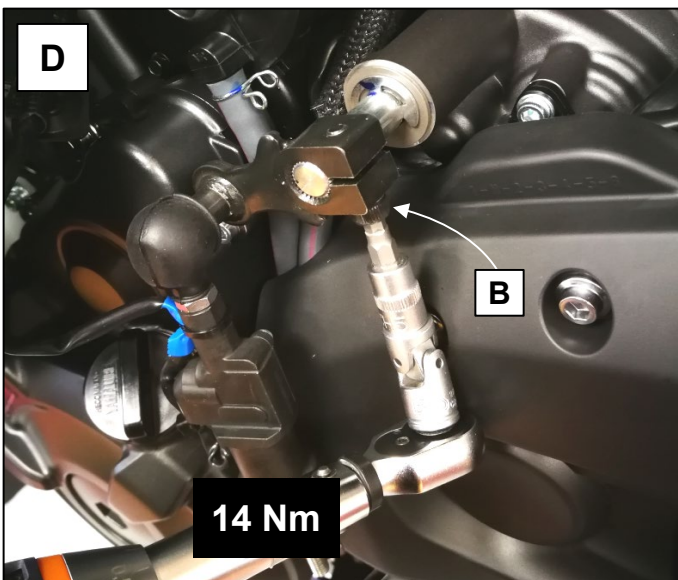
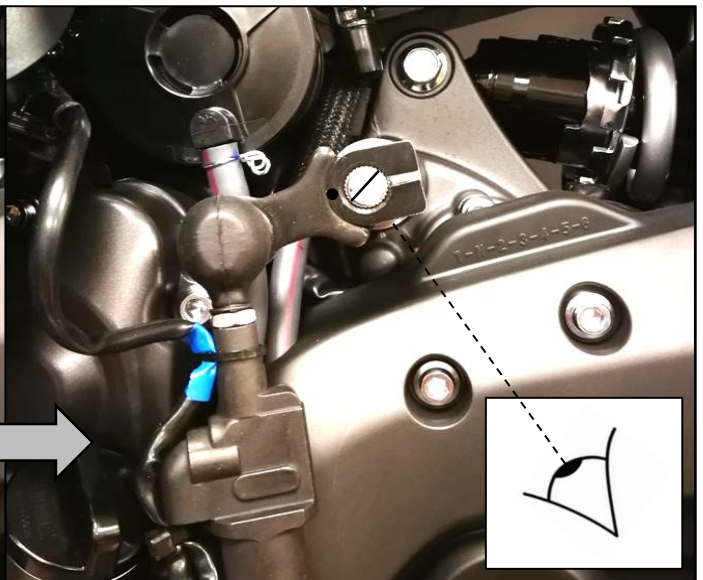
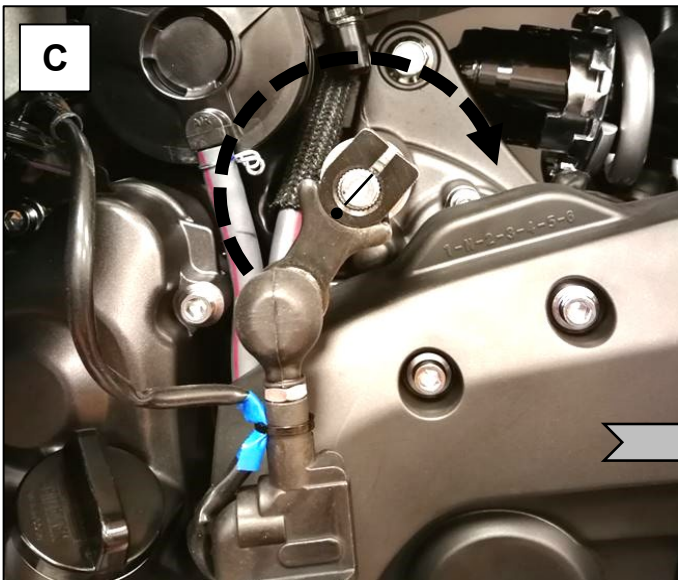
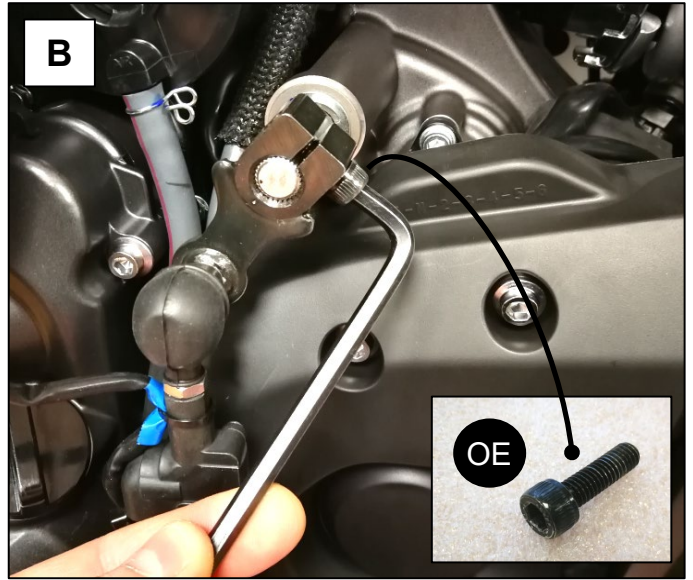
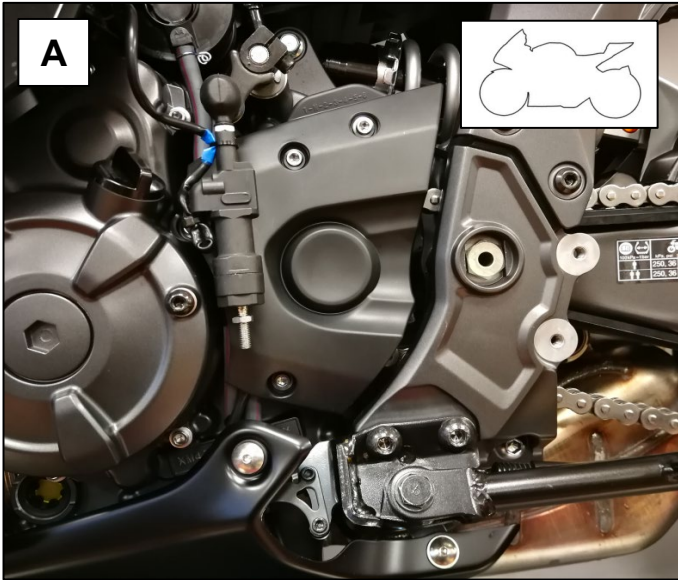

FXR-Y08

Rearset



OPTION 1

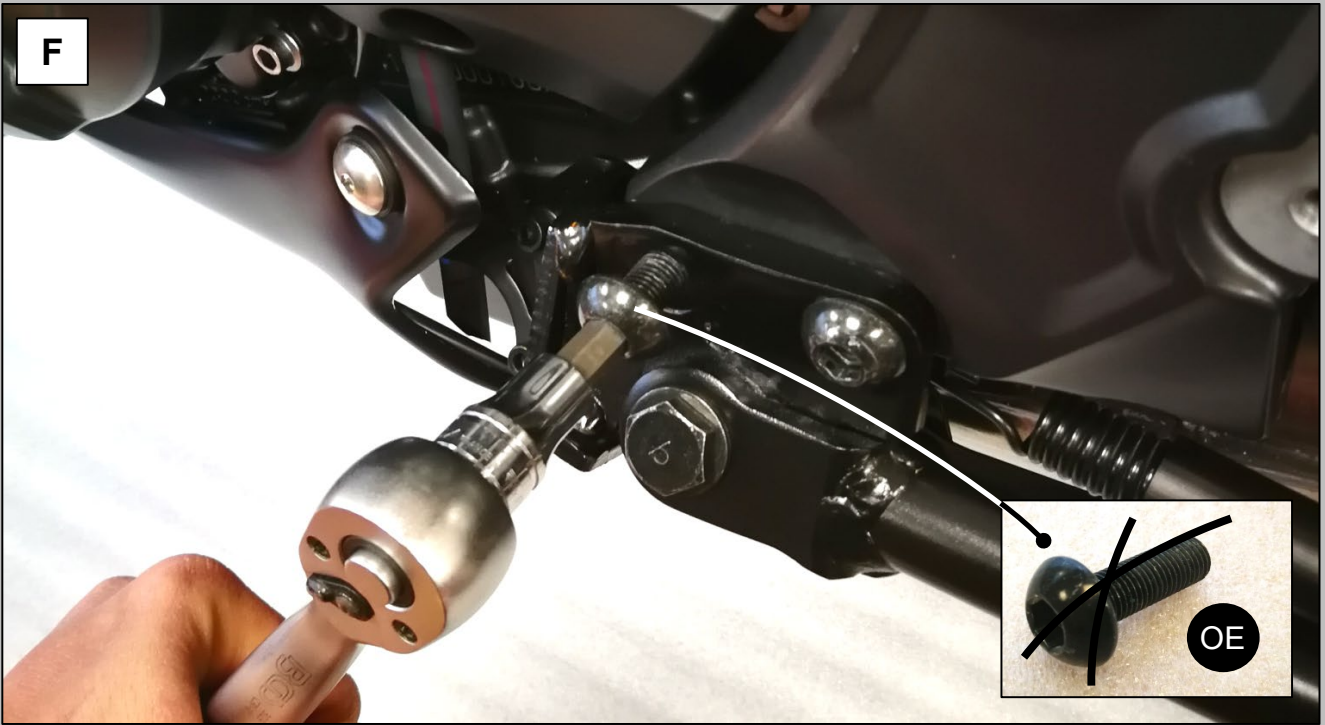

FXR-Y08

Rearset



OPTION 2

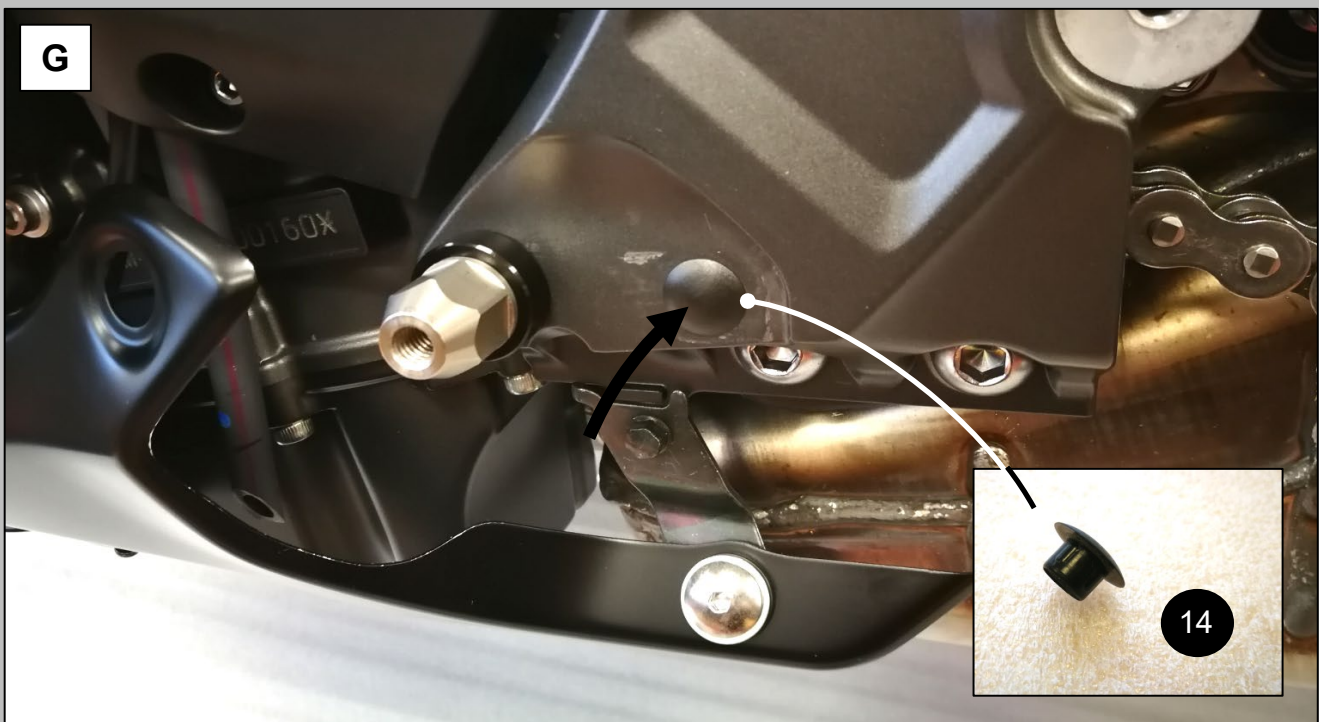
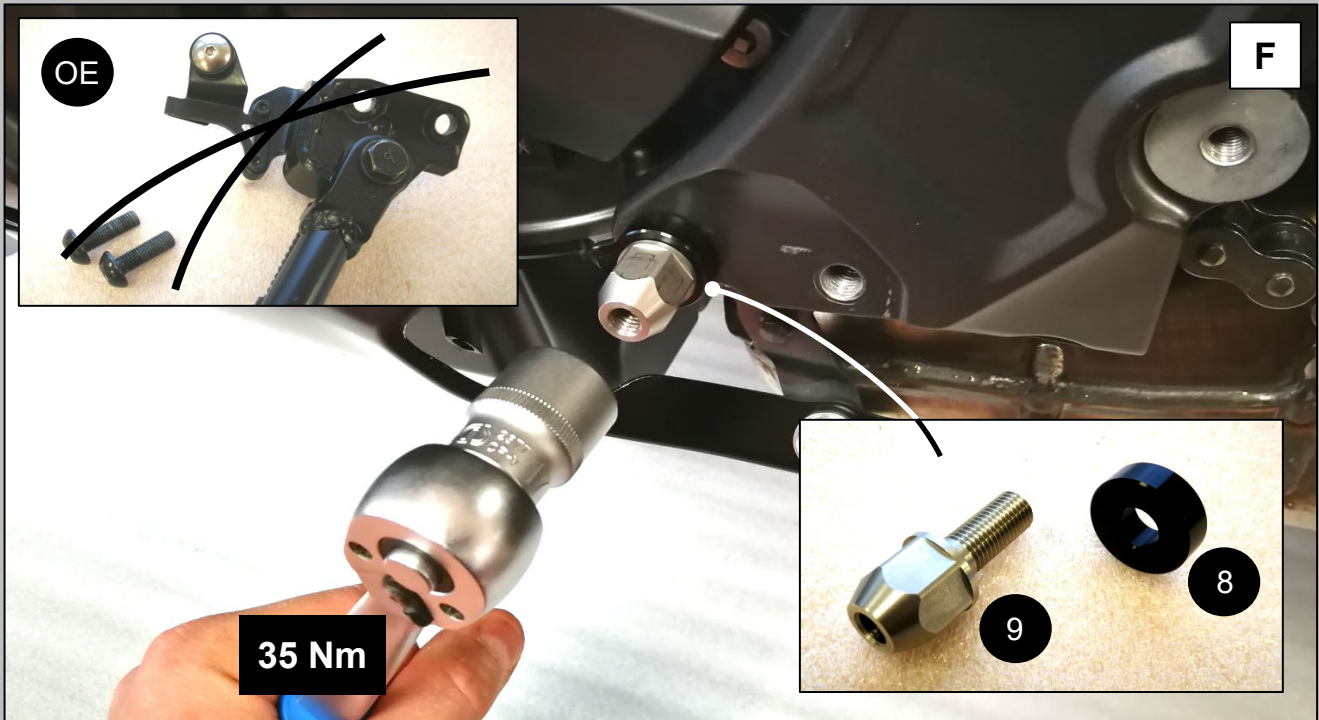

FXR-Y08

Rearset

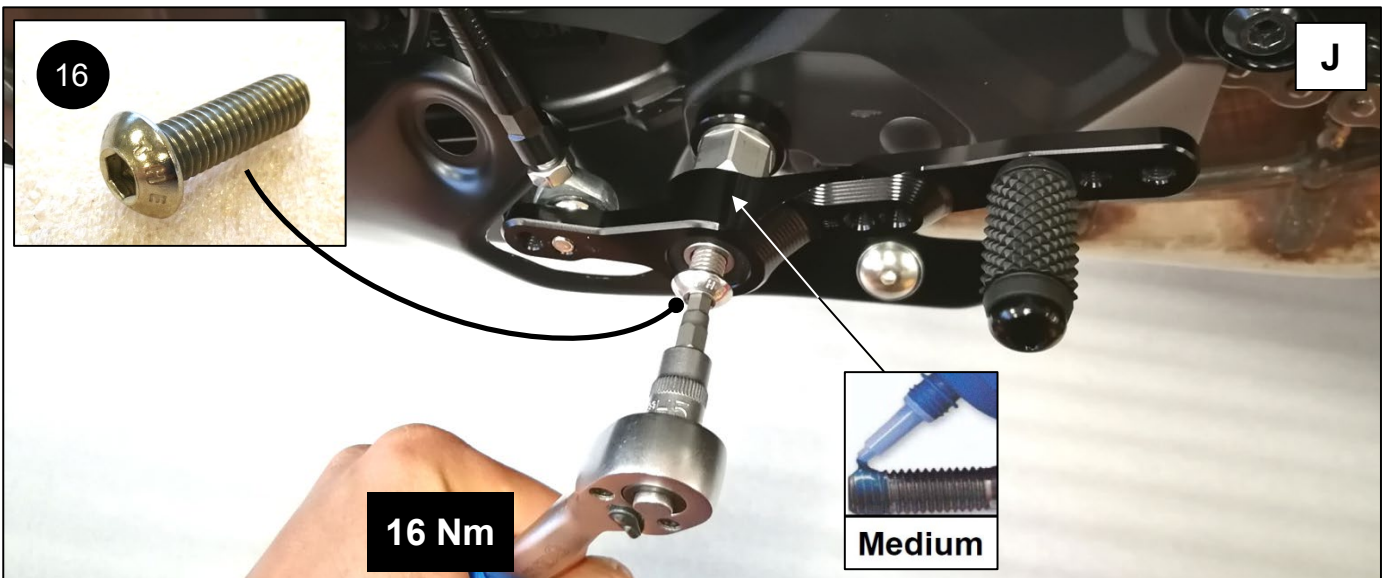
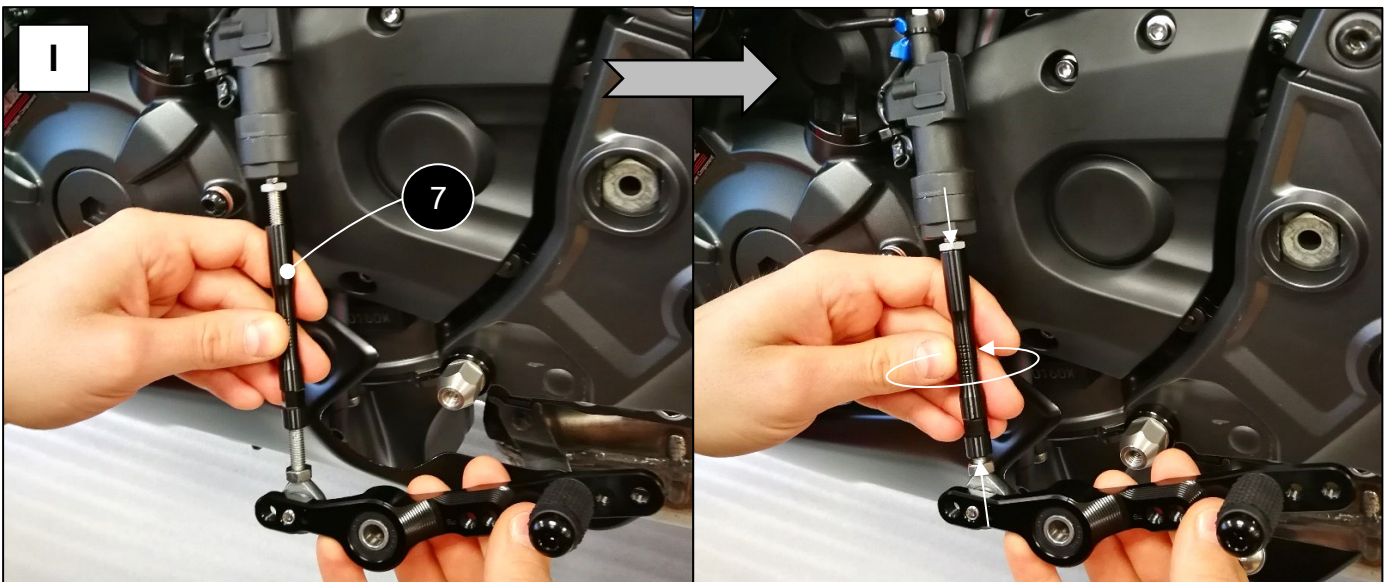
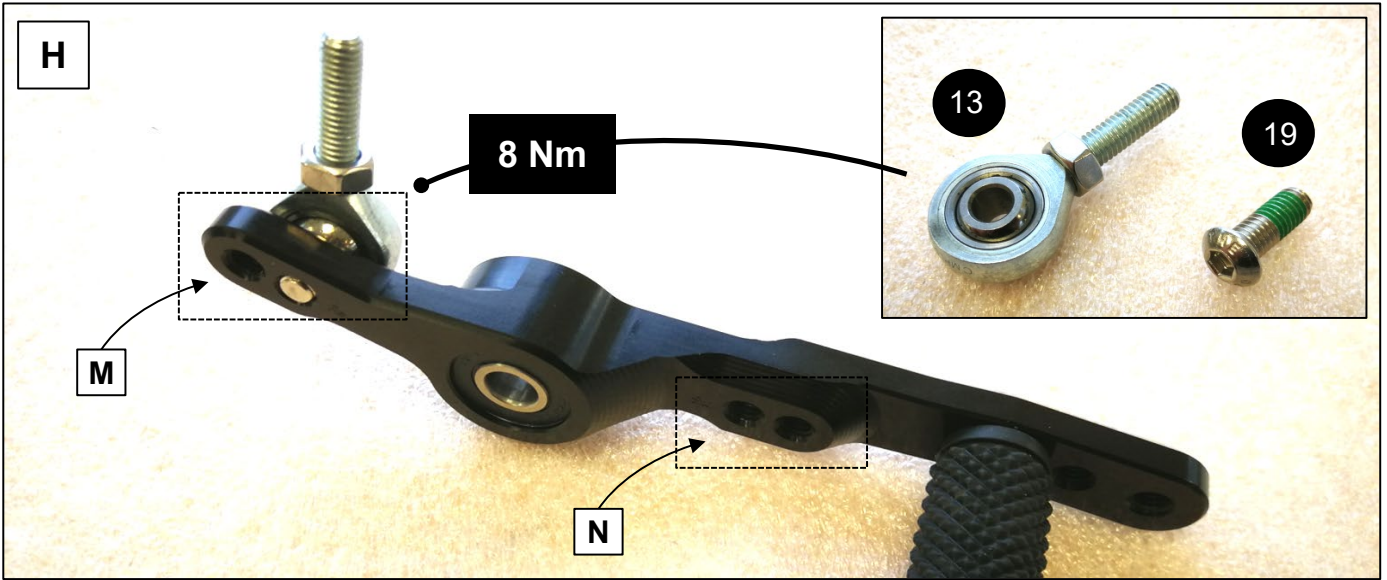

FXR-Y08

Rearset

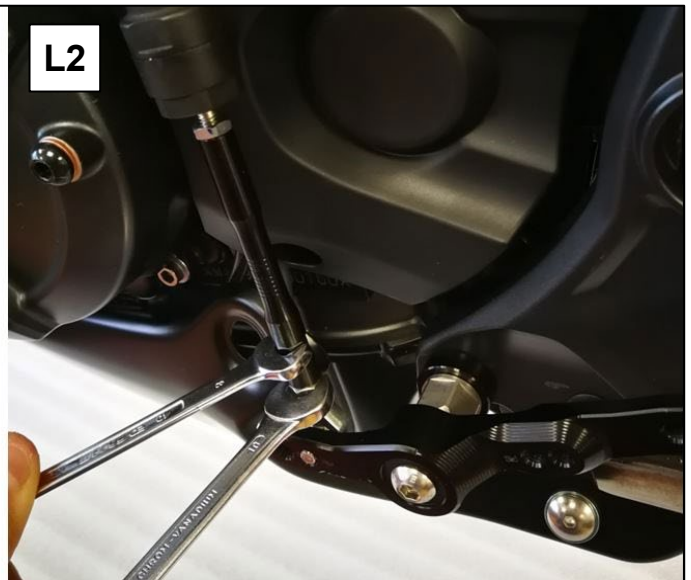
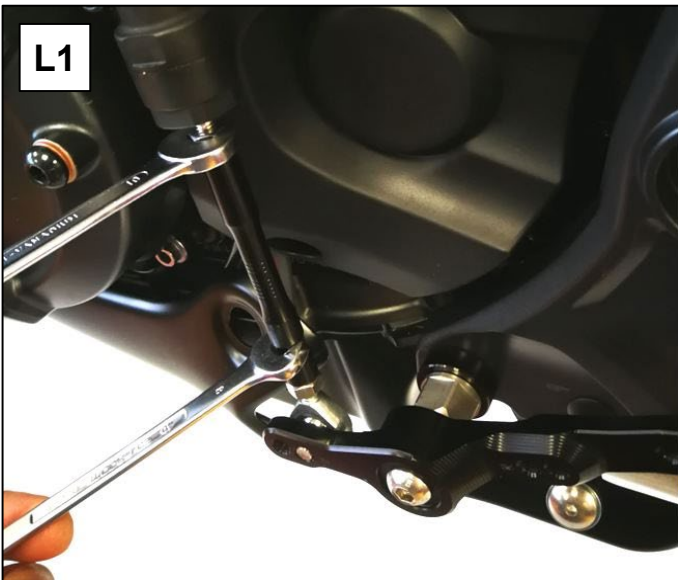

FXR-Y08

Rearset

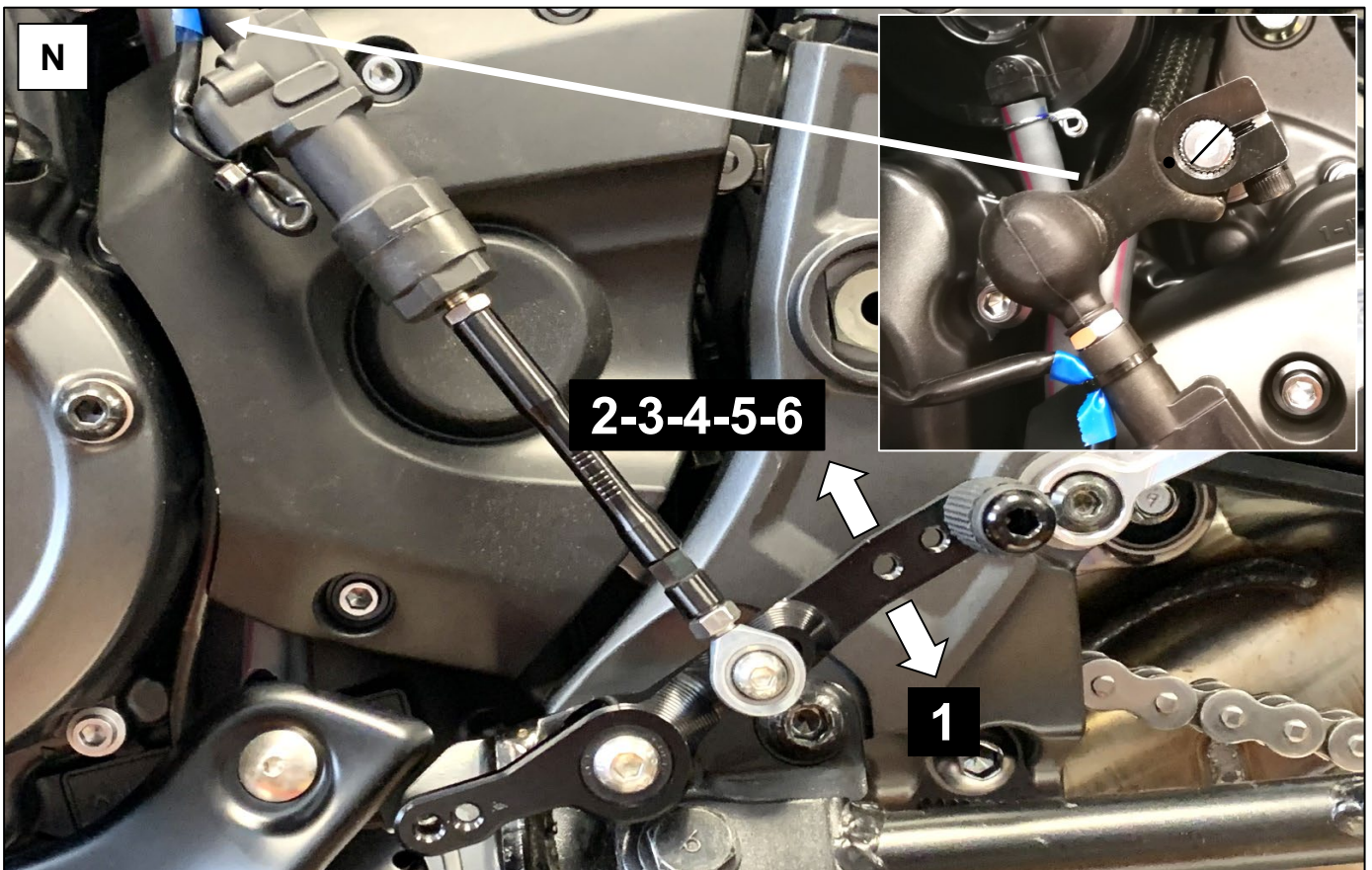
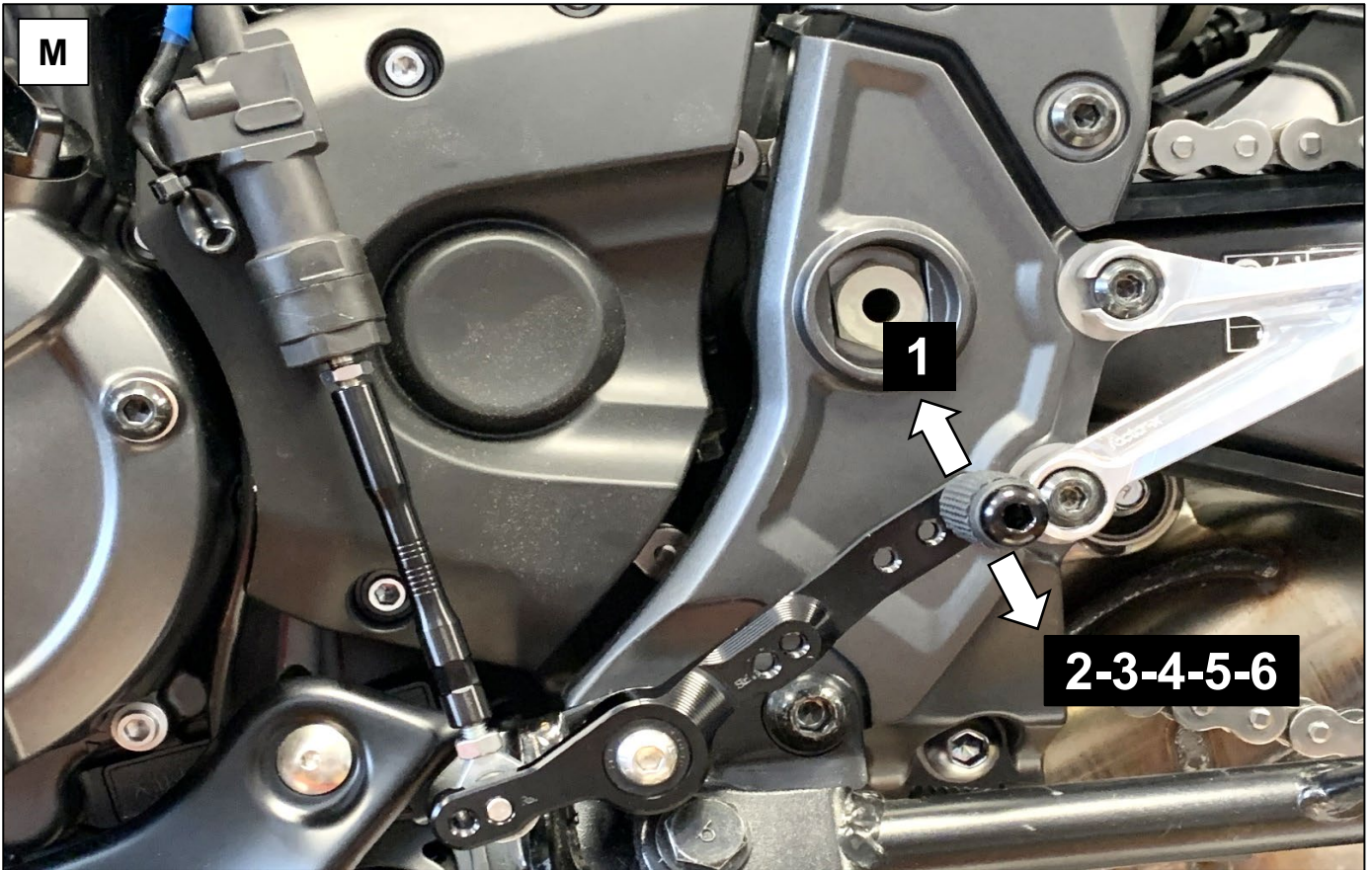

FXR-Y08

Rearset

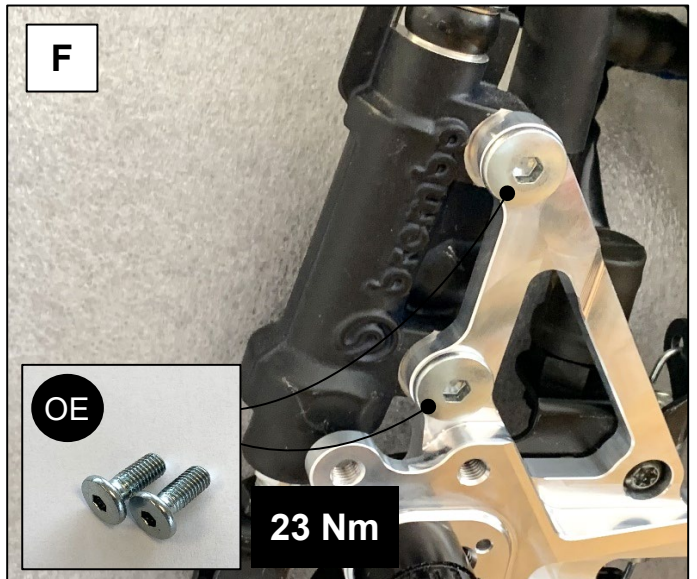
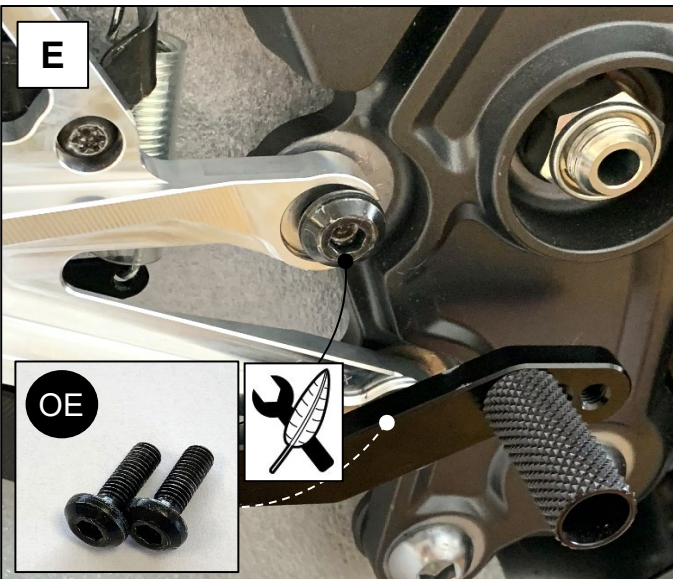
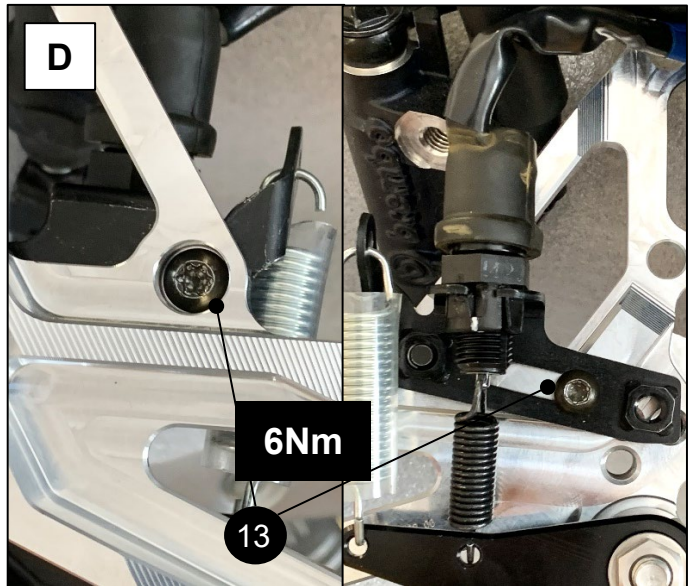
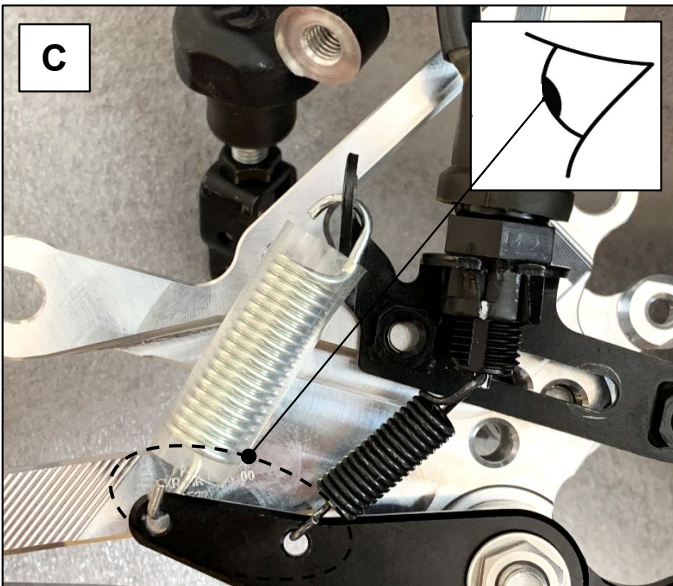
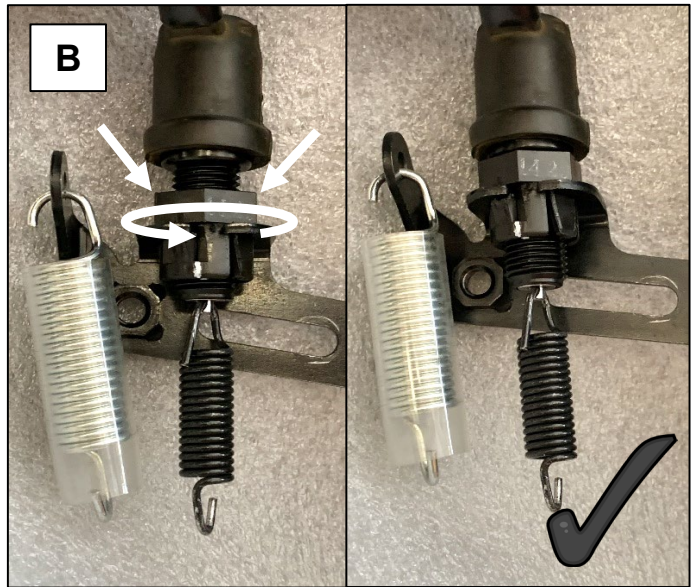
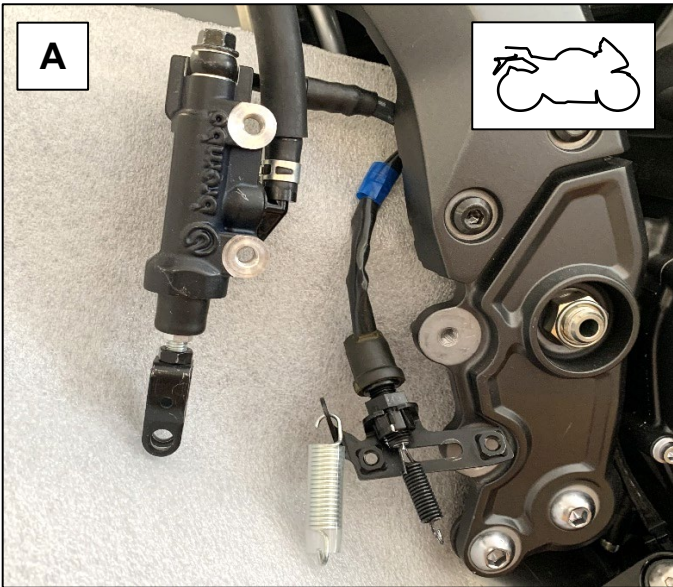

FXR-Y08

Rearset

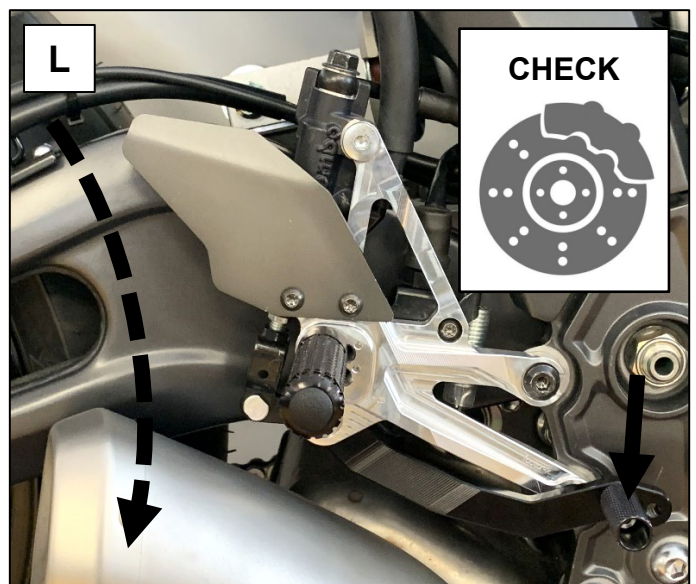
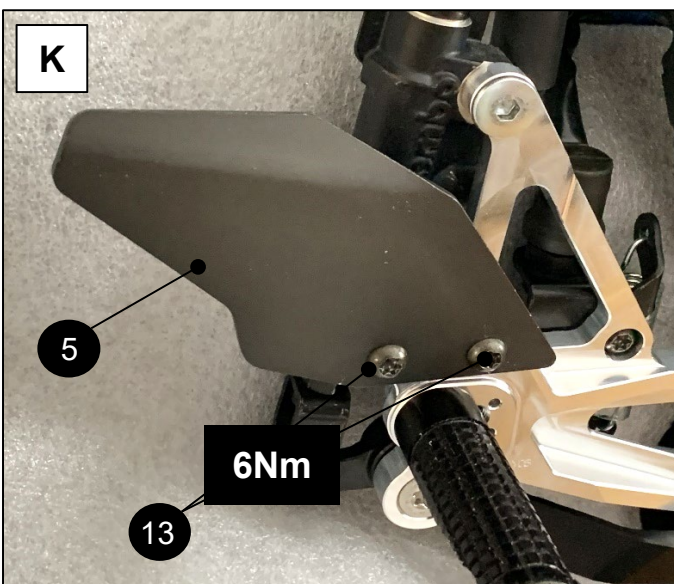
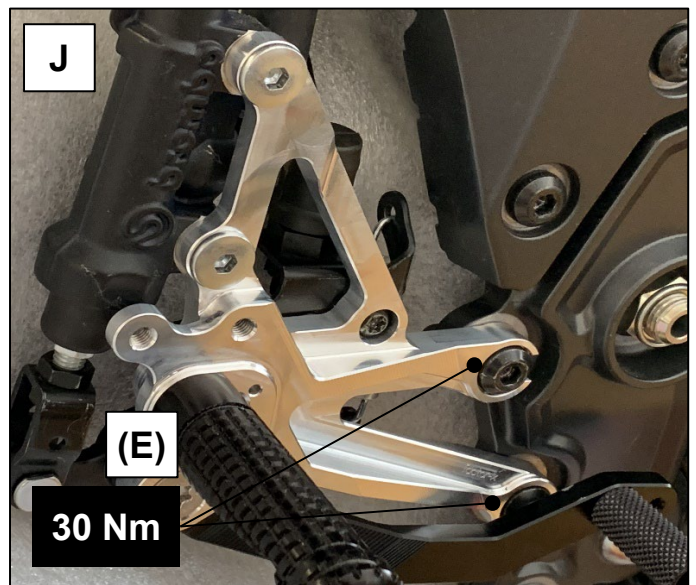
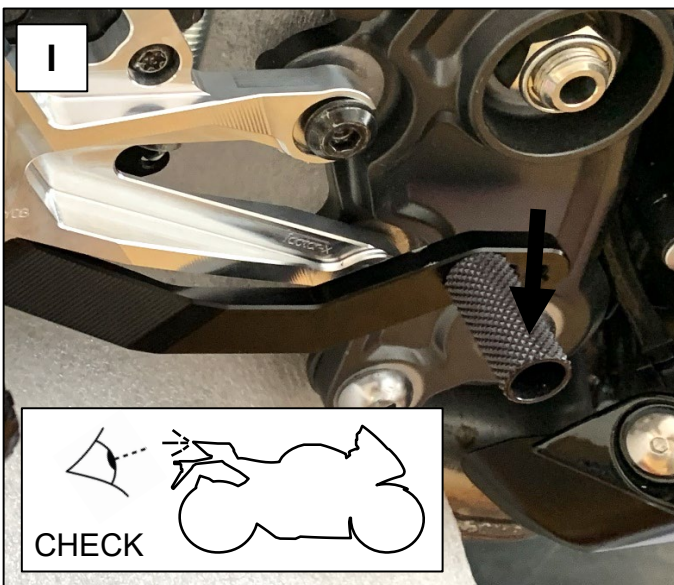
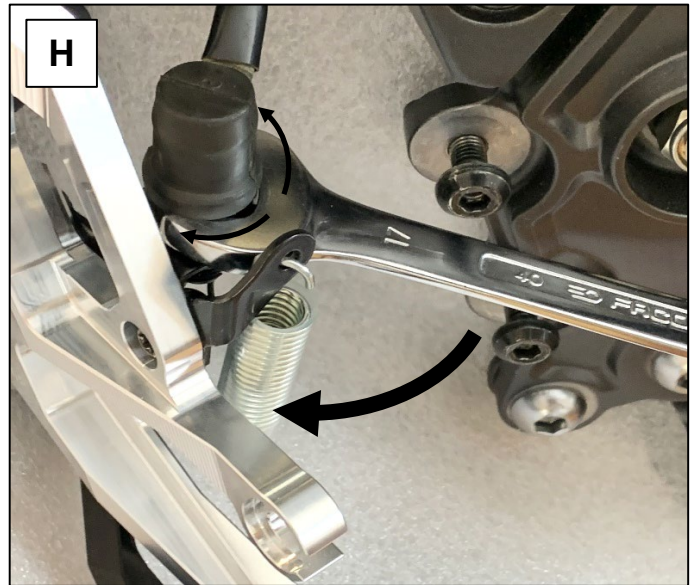
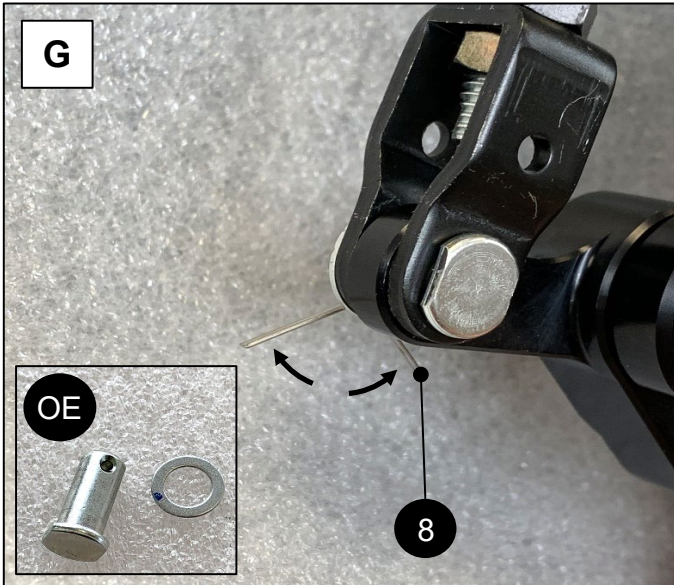

FXR-Y08

Rearset

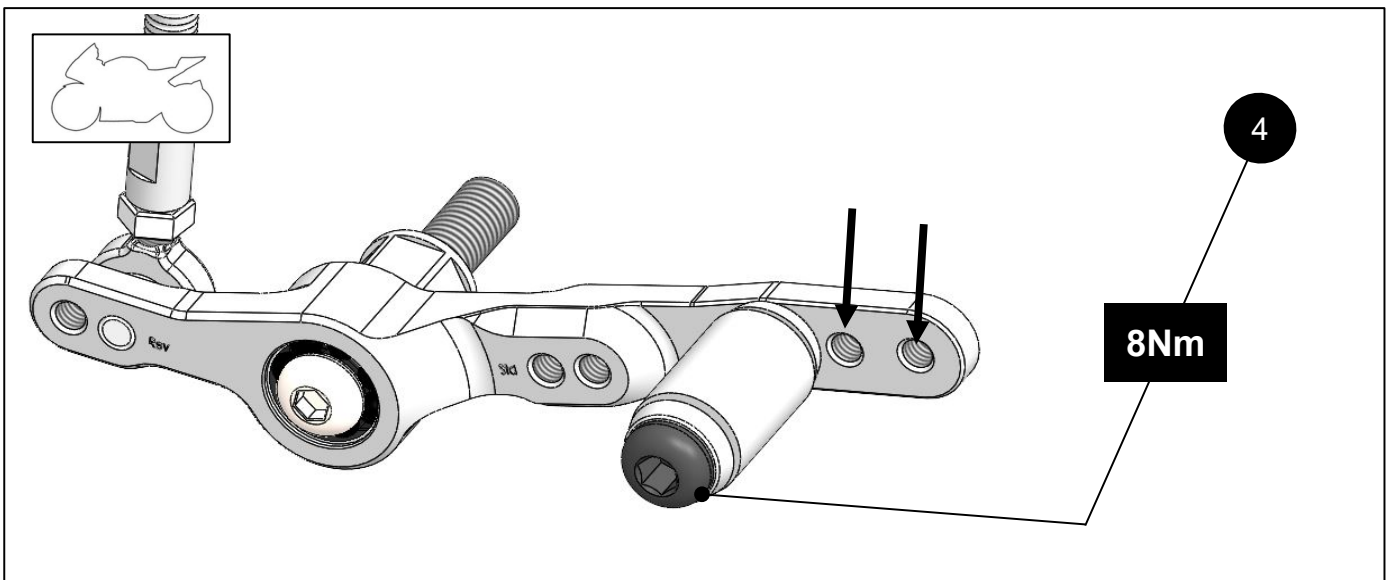
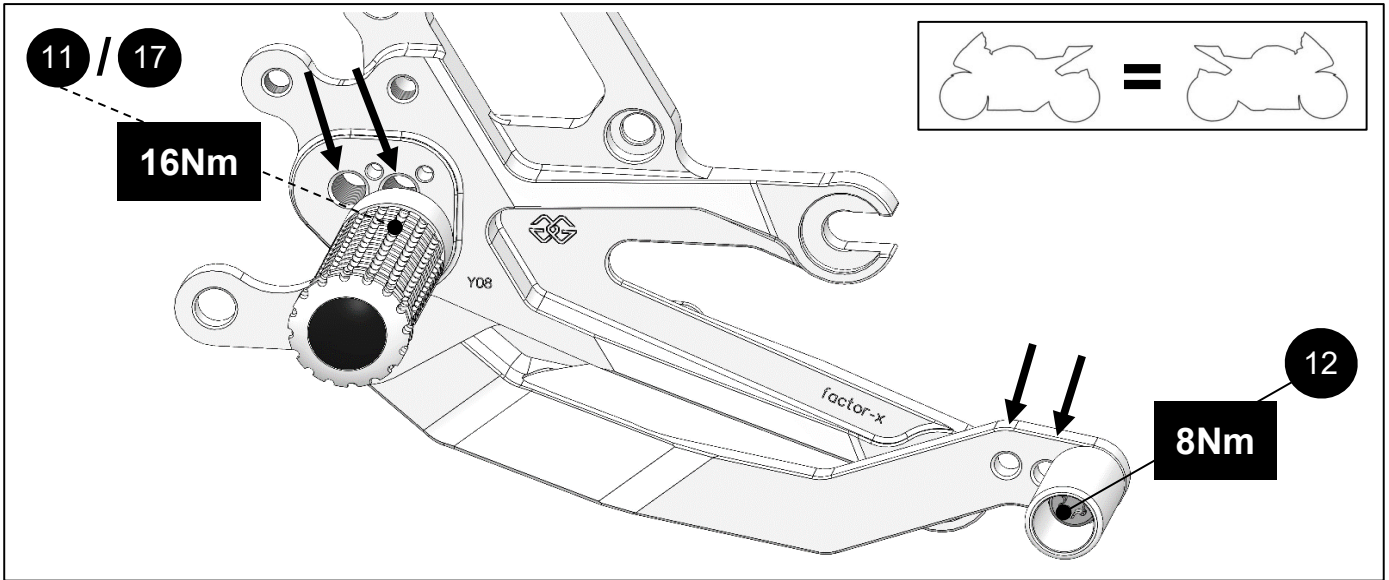

OE Original Position

POS	- ↔ +	↑ ↕ ↓
1	-10	10
2	-10	20
3	-20	20

FXR-Y08

Rearset



Pos.	Part-No.	Qty.	OK
SMF1016			
1	M8x25-7380-VA	1	
2	M6x16-7380-VA PRECOTE 10-1	1	
3	M6x10-7380-8.8-TX-VZS	4	
4	SPS-22	1	
5	SPL-1,6-VA	1	
6	GAKFL6 + M6-L-4032-VA	1	
7	42750PE	1	
RGP60			
8	DS-24-10,2-8-B	1	
RGP60			
9	USW08-B	1	
SIMF1016			
10	CAR-16-R-B	1	
11	TGA 144XT0020	1	
12	FXR-Y08 ABA	1	
		MA	
		Datum	